

How to operate.

Changing the filters

Filter changing and cleaning

Changing the main Rediair filter is displayed by the filter indicator button located on the digital display.

Pre-filters should be cleaned regularly, at least once a month.

The Rediair filter indicator displays the status of the main filters. After 3000 hours of operation, this indicator will light up continuously red, prompting you to replace the main filters. If the filter indicator flashes red intermittently, it is time to clean the pre-filters.

Please refer to the next 7 steps on how to clean the Rediair pre-filters, air outlet and particle sensor.

⚠ WARNING

Before dismantling Rediair to perform filter maintenance/replacement, a local risk assessment should consider the appropriate PPE.

NOTE

Before first use, the Rediair filters must be removed from their protective packaging, making sure the retaining strap points outwards before installation.

⚠ WARNING

Always unplug the Rediair before dismantling device to perform filter maintenance/replacement,

1

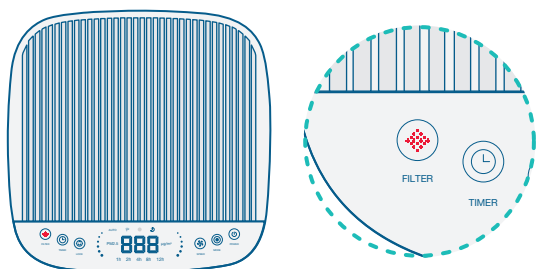

When filter indicator (on the LCD touch control panel) **flashes red intermittently**, it is time to clean the pre-filters.

2

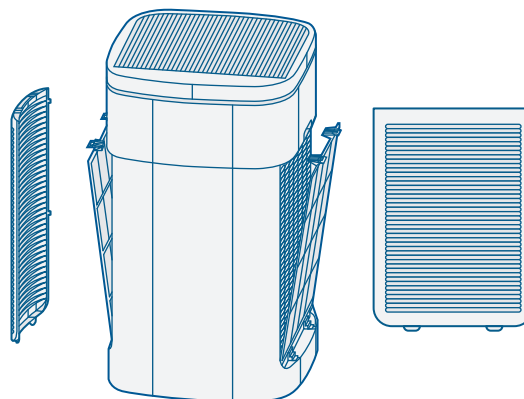

Remove the external covers and the pre-filters (both sides).

3

The pre-filters can be rinsed with clean water

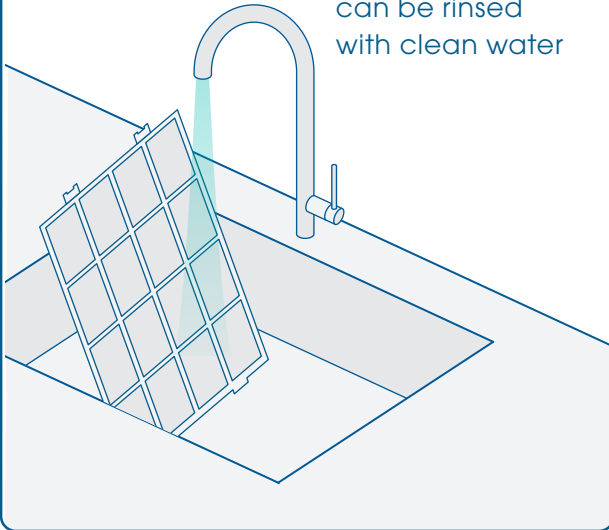

4

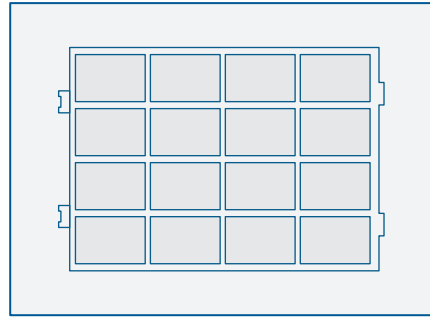

The pre-filters must be completely dry before being used again as any remaining moisture could potentially cause damage to the HEPA 14 filter.

5

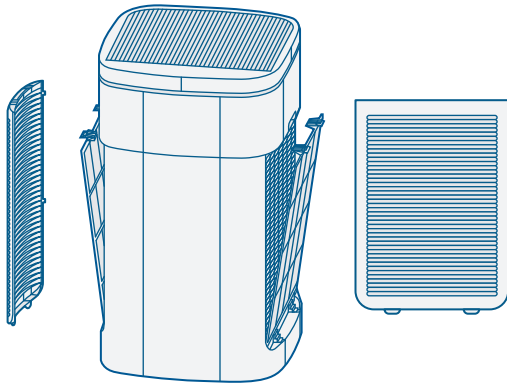

Re-install the external covers and the pre-filters (both sides). **Note:** Ensure external covers are fitted correctly or the Rediair will not power-on.

6

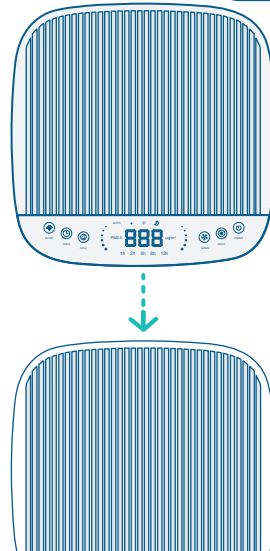

To clean Rediair's air outlet, lift the grill from the side with the arrow symbol and clean the area with a dust cloth.

7

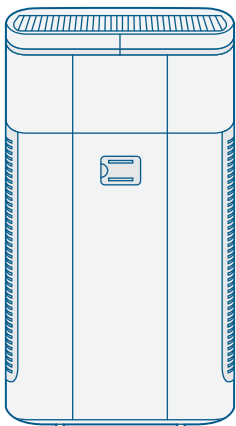

To clean the particle sensor (back of Rediair) lift flap and carefully clean with a cotton swab. This should be done every 2 months or if the LED air indicator consistently shows poor air quality.

Disposal

Used Rediair filters can be disposed of following local waste guidance policies. Also, if the device has been used in polluted air situations, the filter must be packed into an airtight bag and disposed of per local waste guidance policies. In the case of contamination with viruses, please consult local guidance for the appropriate PPE. Respiratory protection is recommended at a minimum of FFP2.

Please refer to the next 11 steps to dispose and install new main filters and pre-filters.

1

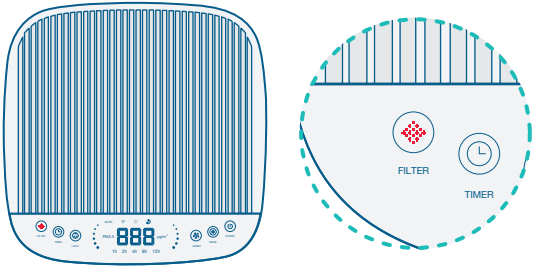

When filter indicator (on the LCD touch control panel) **lights up continuously red**, it is time to change the pre-filters and main filters.

2

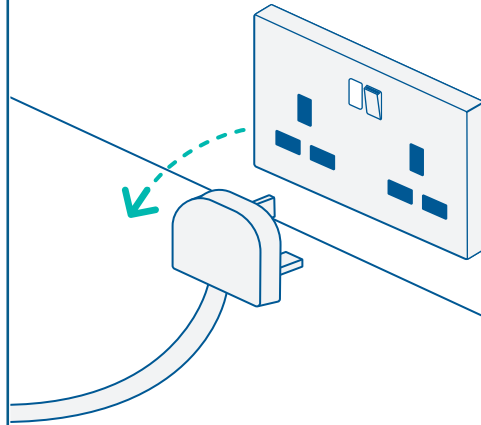

Switch off device and disconnect the power supply.

3

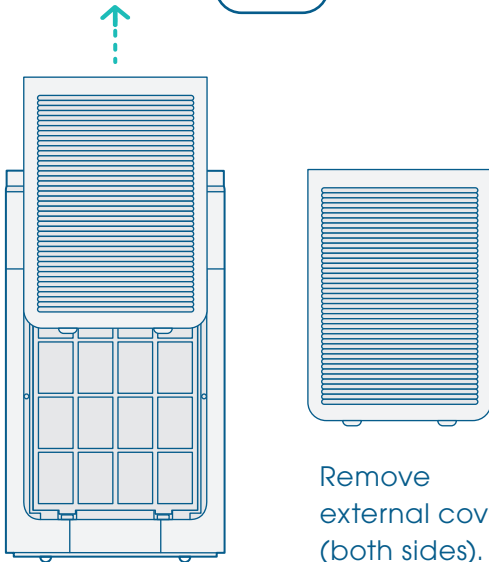

Remove external covers (both sides).

4

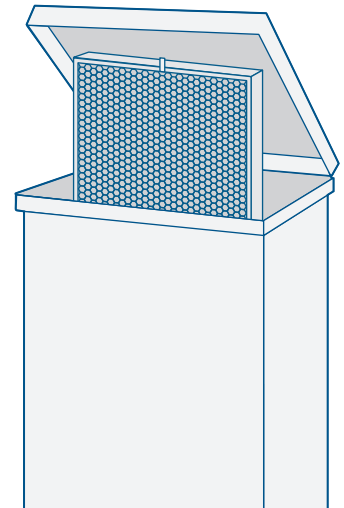

Remove pre-filters and main filters, and dispose of them (both sides).

5

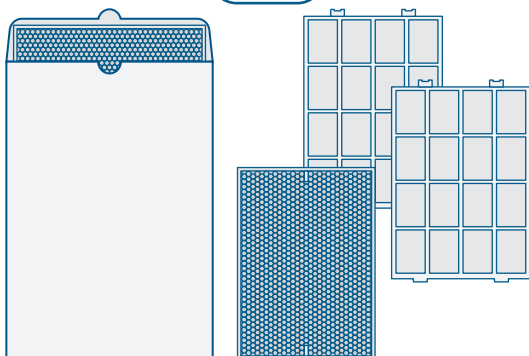

Remove new main filters and pre-filters from box.

6

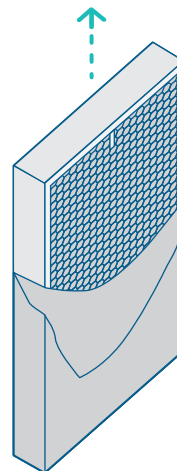

Remove the plastic wrap from the filters.

7

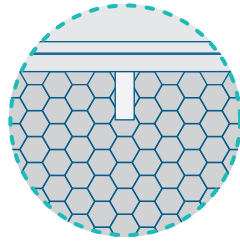
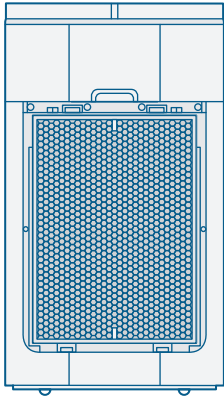

Install the new main filters (both sides), making sure that the tabs are facing outwards.

8

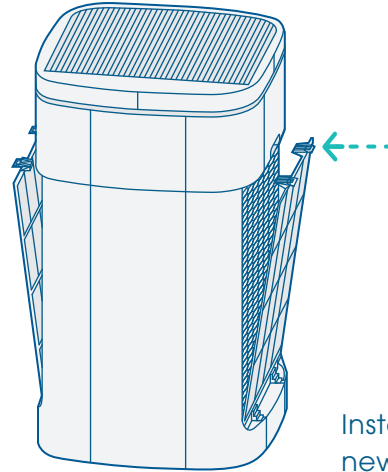

Install the new pre-filters (both sides).

9

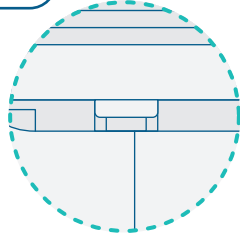
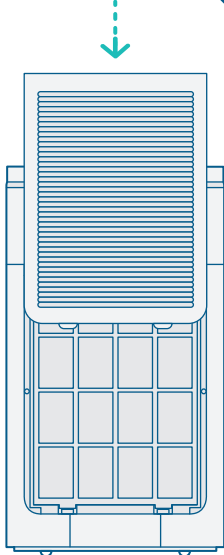

Re-install the external covers (both sides). **Note:** Ensure external covers are fitted correctly or the RediAir will not power-on.

10

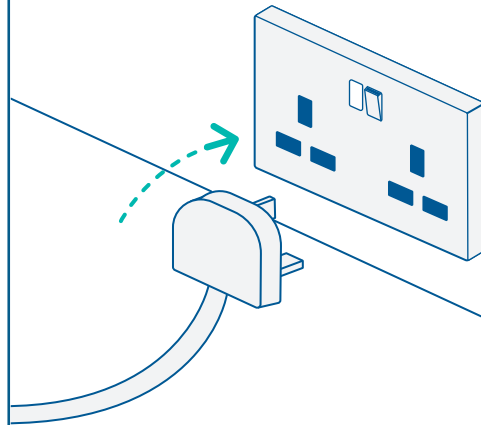

Connect the power supply.

11

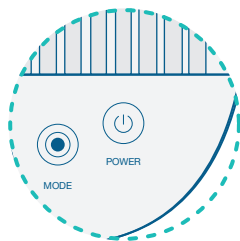

Switch on the RediAir via the LCD touch control panel.

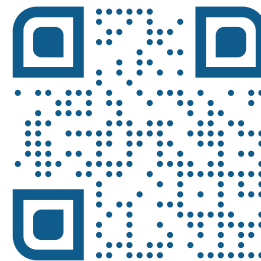

Scan QR code for full product manual and translations.